

QGEP ... Mini

Steckverschraubung, zylindrisch, mit O-Ring, Außensechskant

Gewinde	ØD Schlauch	A	B	C		Artikel-Nr.
M3	3	15,0	3,0	7,0	6	200095058
M3	4	17,0	3,0	10,0	8	200095059
M5	3	16,0	3,0	9,0	8	200095060
M5	4	16,0	3,0	10,0	8	200095061
M5	6	19,0	3,0	12,0	10	200095062
M6	3	17,0	4,0	9,0	9	200095063
M6	4	17,0	4,0	10,0	9	200095064
M6	6	18,0	4,0	12,0	10	200095065
G 1/8"	4	15,0	5,0	12,0	10	200095066
G 1/8"	6	18,0	5,0	14,0	10	200095067

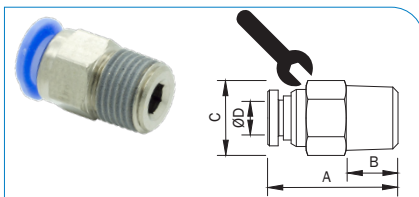

QGEPK ... Mini

Steckverschraubung, konisch, Gewinde PTFE beschichtet, Außensechskant

Gewinde	ØD Schlauch	A	B	C		Artikel-Nr.
R 1/8"	4	17,0	8,0	12,0	10	200095068
R 1/8"	6	20,0	8,0	12,0	10	200095069

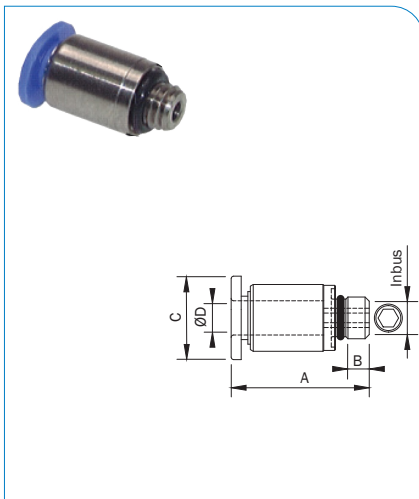

QGIP ... Mini

Steckverschraubung, zylindrisch, mit O-Ring, rund, Innensechskant

Gewinde	ØD Schlauch	A	B	C	Artikel-Nr.
M3	3	16,0	2,0	7,0	200095070
M3	4	18,0	2,0	10,0	200095071
M5	3	18,0	3,0	8,0	200095072
M5	4	18,0	3,0	10,0	200095073
M5	6	20,0	3,0	10,0	200095074
M6	3	19,0	4,0	9,0	200095075
M6	4	20,0	4,0	10,0	200095076
M6	6	20,0	4,0	12,0	200095077
M7	4	18,0	3,0	10,0	200095078
M7	6	19,0	5,0	10,0	200095079
G 1/8"	4	16,0	5,0	12,0	200095080
G 1/8"	6	17,0	5,0	12,0	200095081

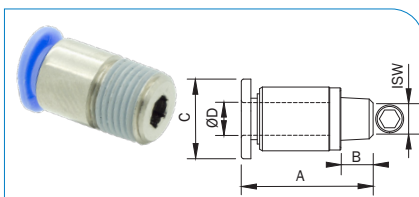

QGIPK ... Mini

Steckverschraubung, konisch, Gewinde PTFE beschichtet, rund, Innensechskant

Gewinde	ØD Schlauch	A	B	C	ISW 	Artikel-Nr.
R 1/8"	4	17,0	7,0	11,0	3	200095082
R 1/8"	6	21,0	7,0	12,0	4	200095083

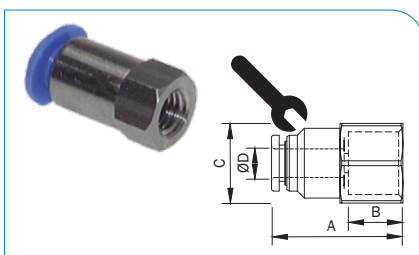

QMAP ... Mini

Steckverschraubung, zylindrisch, Außensechskant

Gewinde	ØD Schlauch	A	B	C		Artikel-Nr.
M3	3	15,0	3,0	9,0	8	200095084
M3	4	17,0	3,0	10,0	8	200095085
M5	3	17,0	5,0	9	8	200095086
M5	4	18,0	5,0	10,0	8	200095087